



ISO 19650
Certified

Corporate Profile



pinnacleinfotech.com



**Pinnacle
Infotech**

Construct
Certainty, with
Technology

Mission

Help the AEC industry optimize resources, cost and quality through innovative use of technology for:

- Sustainable and efficient design
- Collaborative pre-construction planning
- Agile construction process
- Reliable facility management

Vision

Lead the global AEC industry to certainty and efficiency using technology.

Associations:



Our Values

- E Excellence**
We take pride in our passion for excellence. It is a way of life for us.
- A Agility**
We are always at the edge of technology and driven by agile transformations.
- R Reliability**
We have ISO-certified processes and workflow to produce consistent and reliable performance.
- T Teamwork**
Pinnacle provides an environment where teams collaborate effectively to excel.
- H Honesty**
We win the trust of our stakeholders through integrity, straightforwardness, and transparency.

Our Way of Giving Back

Ankuran Foundation

A first-of-its-kind, not-for-profit, national network of world-class learning centers that impart Science Education through experiential learning to school students from diverse backgrounds. To learn more, visit Ankuran.org



Index

1. Introduction	Page 04
2. Our Team	Page 04
3. Why Pinnacle?	Page 05
4. Our Services	Page 06
4.1 Pre-Bid Estimation	Page 06
4.2 BIM Services	Page 06
4.3 BIM Consulting	Page 08
4.4 Facilities Management	Page 10
4.5 Digital Twin	Page 10
4.6 CAD Drafting Services	Page 11
5. Verticals We Serve	Page 11
6. Our Work Process	Page 11
7. Awards & Recognition	Page 12
8. Our Projects	Page 12
9. Clients Speak	Page 15



1. Introduction



Durgapur office campus (HQ)

Pinnacle Infotech Solutions offers Building Information Modeling (BIM) solutions to Architecture, Engineering & Construction (AEC) firms globally. We provide Design & Consultancy Services, Pre-construction services - Constructability review and Coordination, Value Engineering, logistic planning, construction management, Facilities management and Digital Twin.

In the last 30+ years, Pinnacle has been leading the Global AEC industry and has completed more than 15000+ projects across 43+ countries.

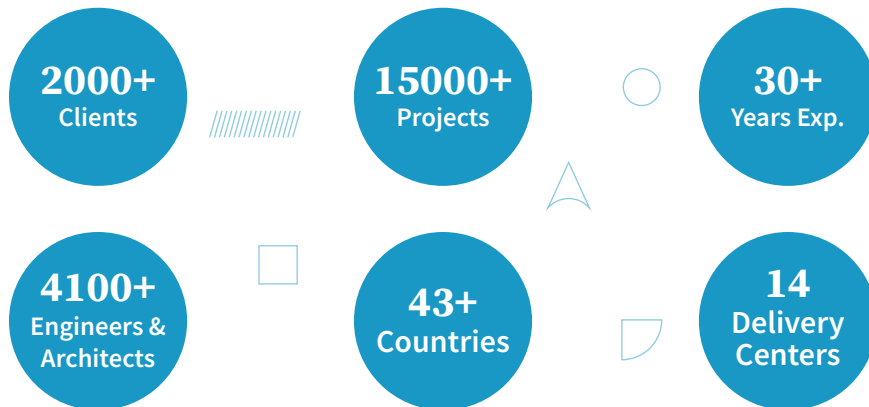

2. Our Team

Pinnacle's significant contribution to Building Information Modeling is made possible by its highly qualified and experienced workforce, including engineers, architects, and other experienced professionals. All our employees are well-versed in handling international construction codes and standards. We are proud of the diverse team and their global experience.

Employee Background

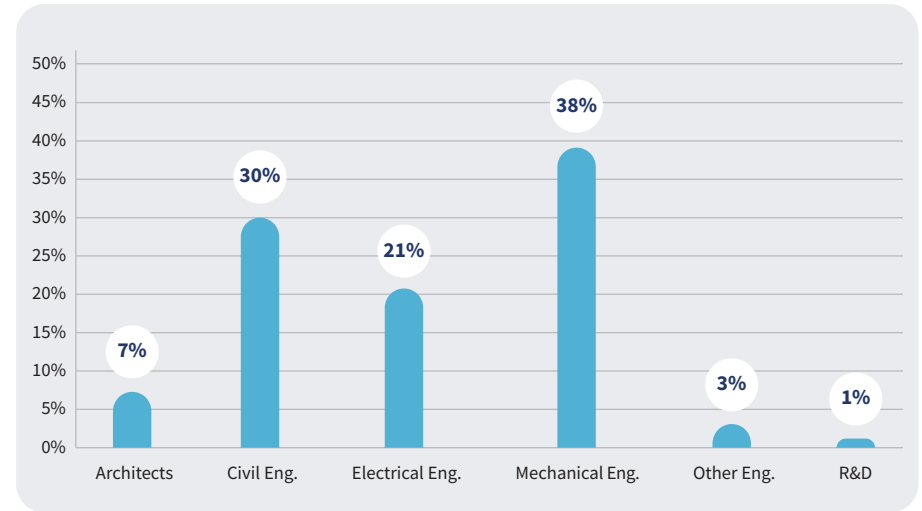

Workforce Growth

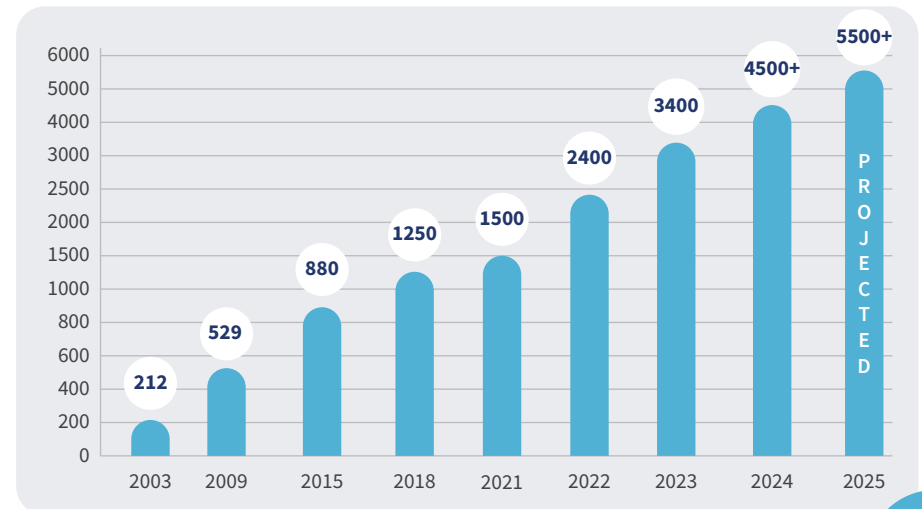

Our Infrastructure

Pinnacle has large state-of-art campuses in Durgapur, Jaipur, Kolkata & Madurai, comprising facilities like High-speed Bandwidth, Blade servers, an R&D center, a Datacenter, recreational zones, playgrounds, and more.

We also have equipped global delivery centers in the US (Houston, Atlanta, and San Jose), Canada (Toronto), UK (London), KSA (Riyadh), UAE (Dubai), Singapore, Germany (Cologne), and Japan (Tokyo) that allow our employees to work in the same time zone as our customers.

Pinnacle's Construct-ability Installation Lab gives construction site experience to employees, integrating theoretical learning with practical experience. It enables our employees to deliver BIM solutions on time and with accuracy.



3. Why Pinnacle

Each of our employees has ingrained in themselves the core values - 'EARTH' of our organization.



Excellence

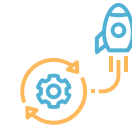

Agility



Reliability



Teamwork



Honesty

Excellence

Excellence is a way of life for us. Our commitment to hard work, creativity, and innovation allows us to reach our full potential in terms of approach, operations, and collaborations. We foster a culture of excellence from the ground up within our organization to achieve operation at the highest industry standards.

Agility

We understand that every business is different. We are highly agile and can adjust quickly to changing market conditions and client requirements. In addition, we offer a variety of business models to suit your specific needs at competitive prices.

Reliability

Pinnacle relies on trusted processes to consistently produce excellent results. We have over 30 years of experience in the AEC industry, and our work processes are ISO-certified.

Teamwork

We work together to scale every challenge. We understand that it is only through teamwork that we can provide the best possible results for our customers. Pinnacle fosters a team-oriented culture where everyone is valued, and their contributions are encouraged and recognized.

Honesty

Honesty is our key value, and we hold ourselves to the highest standards of integrity. We strive to be transparent and clear in our communication to ensure that our clients get the best value for the money.

4. Our Services

Pinnacle offers end-to-end BIM Services allowing clients to get complete control of construction projects. Our BIM engineers work with 3D, 4D, 5D, 6D, and 7D BIM to facilitate project coordination, collaboration, construction management, asset management, risk mitigation, logistic planning, and cost estimate. We follow a structured approach for providing BIM Consulting, Engineering, Modeling, Facilities Management, and Digital Twin services.

4.1 Pre-Bid Estimation

Pinnacle's pre-bid estimation Services aid contractors in winning bids through accurate estimates according to industry standards.

Digital estimation tools offer estimators the capability to estimate quickly. Moreover, they allow customization of labor and material rates as per requirements.

4.2 BIM Services

Architectural Design

Our dedicated team of skilled personnel interacts with architects to understand their design intent and provides value-added support as the design evolves from the conceptual /schematic stage to the construction stage.

Structural Analysis

Our structural design analysis services design and validates design parameters viz., Bending moment, stress-strain, lateral loading, etc. We utilize advanced design tools like RISA, ETABS, STAD PRO, Tekla & HILTI, etc., to generate accurate reports quickly.

MEP Design Services

Pinnacle works closely with MEP Design Engineering firms during the design development stages. We work with various inputs and validate the design for constructability, applicable codes, performance, and maintenance.

We integrate advanced design tools like Dialux, Elite, PIPENET & ETAP, which enable faster iterations leading to substantial savings in design time and costs.

Energy Optimization

Our team assists you with building energy optimization services to migrate to low-carbon and renewable energy sources to enhance energy efficiency. Whether it's energy system integration or the detailed design of energy infrastructure, we help clients to identify the best path to sustainability.

3D Modeling

We generate coordinated models using 3D Modeling services. It allows our clients to check possible interference among all building systems through 3D BIM Modeling Services.

Our 3D BIM models assist construction companies in visualizing schematic structures before construction. Therefore, it can offer better project planning for our clients.

Constructability Review

We work on BIM models based on the client's RFI response, document the status in a log, and follow up regularly with clients to resolve all constructability issues during the pre-construction stage. As a result, constructability review prevents work stoppages and eliminates rework and wastage of material before the construction process starts.



Before CR
Equipment missing in mechanical plant room
(Air separator, Expansion Tank Break Tank,
Carbon Filter)



After CR
Missing equipment added for optimal
functioning

Clash Coordination

BIM Clash Coordination Services assist in detecting interference between trades during preconstruction. Our BIM Clash detection and coordination services cover the preparation of virtual 3D BIM coordination drawings to ensure that the model is fully coordinated and free from clashes.

Construction Documentation

Construction documents provide the basis for workshop fabrication and on-site installation. They ensure that all stakeholders clearly understand the project requirements and can work together to deliver a successful outcome.

Design Prefabrication/ Spool Drawings

We create spool drawings and maps as per the client's standards. These segmented spools contain details to facilitate prefabrication. Once fabricated, they can be quickly assembled and installed at the site.

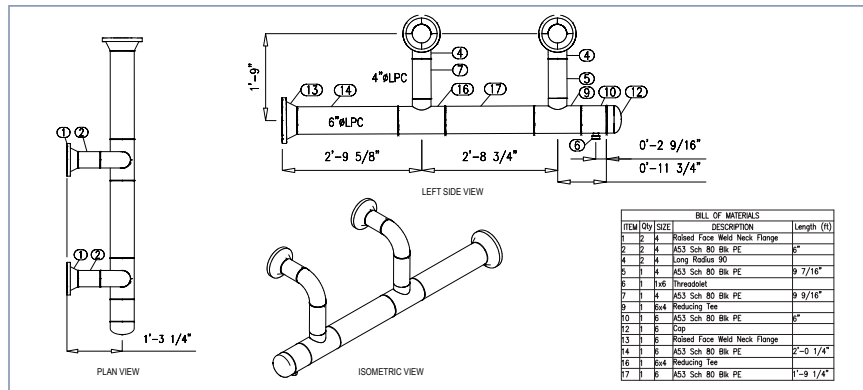

Plumbing Spool Sheet

Quantity Takeoff

We generate accurate Quantity Takeoff from fully-coordinated 3D models. The Quantity Takeoff is automatically updated to reflect any changes in the model.

All equipment and fixtures details are tabulated to help contractors estimate project costs and plan material procurement.

Construction Site Logistics

Construction site logistics plan is necessary for the project to optimize the use of site space and enhance safety.

We help you by creating visual representations to facilitate efficient planning and implementation of various logistical components in a construction site. We evaluate projects meticulously to offer customized logistics solutions.



Construction Site Logistics Sample

4D/5D Construction Simulation & Marketing Presentation

Our 4D/5D Construction Simulation services add a new dimension: the visualization of the project timeline phase-wise. Simulations in construction have a significant role in project planning and estimating material, labor and machinery requirements each day.

We also create compelling BIM marketing presentations to help clients secure competitive bids. Our marketing BIM presentations involve 3D walkthroughs and rendered images to give a lifelike feeling of moving through the construction space in reality through the exterior and interior of the building reflecting the method statement of the contractor.

Laser Scan/Point Cloud Data

Point Cloud data from 3D scanning provides an exact and thorough "as-built" drawing. We capture detailed information about an element in its physical space to enable precise and accurate modeling, coordination, and quantity take-offs.



Input Scan Recap View

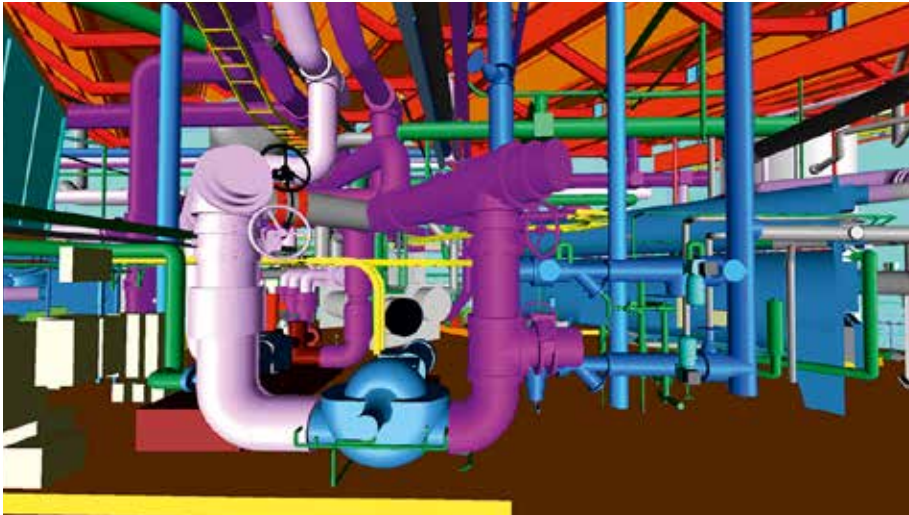

Output BIM 3D Model

4.3 BIM Consulting Services

BIM Strategy Plan

Our BIM Strategy Plan services allow clients to embrace the latest BIM processes and take their workflows to the next level of technological advancement. Clients can expect comprehensive BIM integration into their workflow, including BIM training and advisory services.

BIM Implementation

The transition from traditional processes to BIM-integrated workflows starts with a BIM implementation plan. It outlines the processes, strategies, and workflows to implement BIM in projects. BIM implementation consists of the following stages:

- Audit
- Setting Goals
- Definition of Strategy and Process
- Budget Planning
- Training and Education
- Monitoring

BIM Execution Plan

Using advanced software tools, Pinnacle forms comprehensive BIM Execution Plans for our clients to transform their existing business processes, increase collaboration, and reduce delays in communication. We identify bottlenecks by reviewing existing processes and defining and implementing BIM methodologies to address them.

BIM Training

Organizations that embrace BIM to replace their existing workflow require extensive training tailor-made for their work processes and industry. We can provide the best training so that our clients can leverage the full value of BIM and extract the maximum value for their projects. Our consulting services are an ideal fit for General Contractors, Owners, Architects, and Engineers.

BIM Template and Content Creation

Our BIM experts are highly experienced in transforming products and systems into parametric BIM objects using Revit, while Content Creation makes the product available to designers.

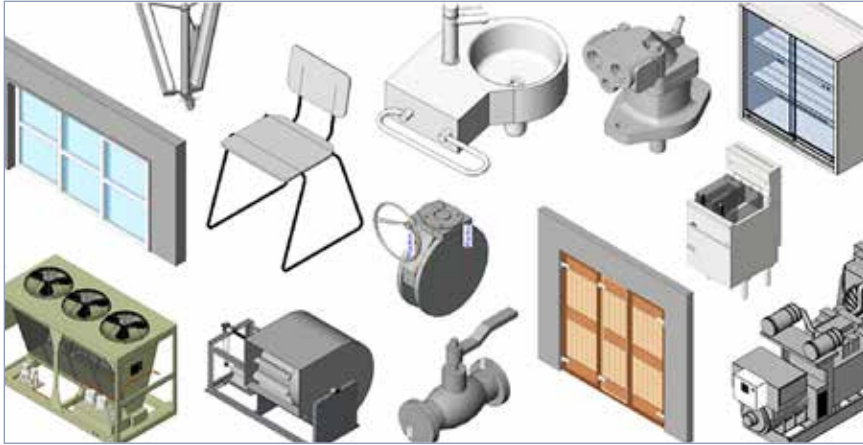

Examples of content creation

BIM IT Infrastructure Planning

BIM IT Infrastructure Planning involves regular audits of existing IT infrastructure for BIM implementation.

- Establishes clarity of project intent to stakeholders
- Delivers critical foundation for business agility
- Ensures data fidelity & stability across the project lifecycle

Value Engineering

Our in-house team brainstorms to re-design the MEP layout to increase efficiency and lower cost. We focus on proper spacing and positioning of hangers to bear maximum load while optimizing cost.

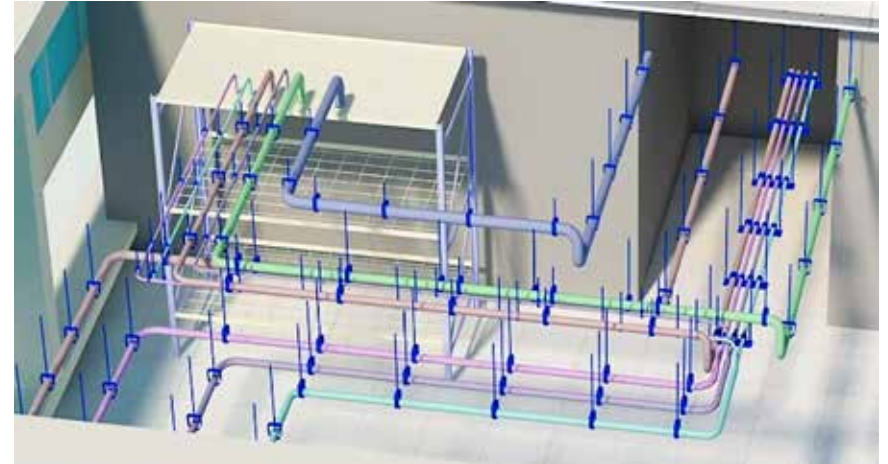

Before VE

No. of Clevis hangers: 100 | Fittings: 300

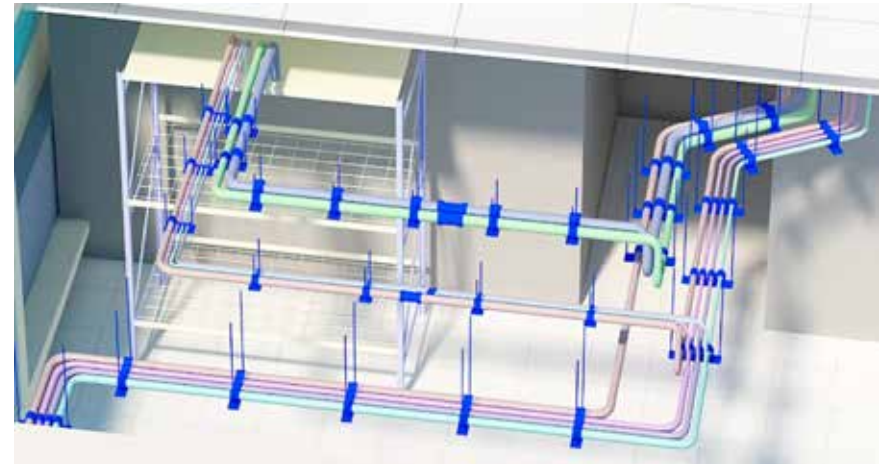

After VE

No. of Trapeze hangers: 70 | Fittings: 210

4.4 Facilities Management

Pinnacle's BIM-centric Facility Management services enable owners and project managers to access accurate information about project design and other components from a central database.

Our experts use the COBie (Construction Operations Building Information Exchange) standard to streamline asset data collection, such as maintenance schedules, equipment information, etc.

The benefits of these services are:

- Centralized platform for easy access to data
- Instant access to the latest data from a single model
- Integration with FM software tools
- Preventive Maintenance Planning

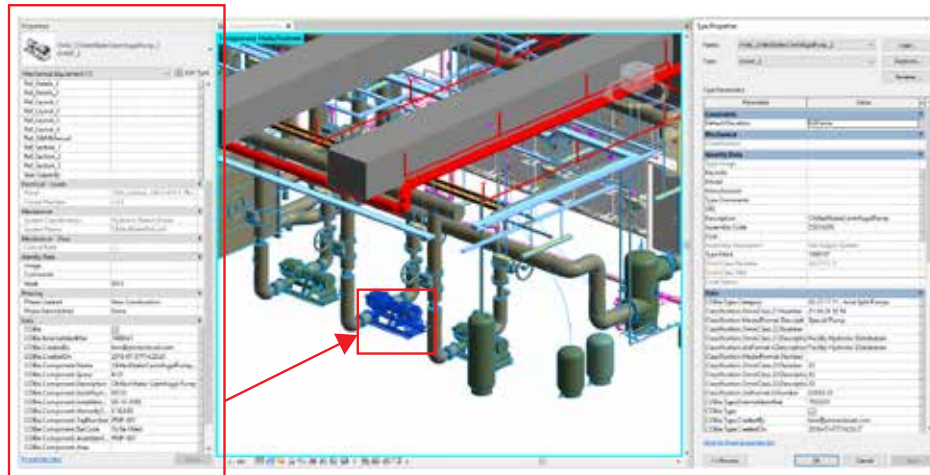

Facility Management Example

4.5 Digital Twin

Digital Twins are intelligent BIM models and dynamic digital replicas of physical assets, processes, and systems that can be used for facility management.

During the construction lifecycle, the BIM model accumulates data as it evolves from one stage to another. The digital twin integrates this multi-stage information to depict the current state of facilities.

Digital Twin benefits include -

- Informed Decision Making
- Real-time Condition Monitoring Dashboards
- Predictive Risk & Failure Assessment
- Preventive Maintenance
- Regular Performance Testing
- Data Analytics with Sensors and IoT
- VR-assisted maintenance



Digital Twin Example

4.6 CAD Drafting Services

Our teams have extensive experience providing the following CAD Drafting services:

- Scanned Drawing Conversion (PDF to CAD)
- Redline Markups Update
- Indexing and Renaming
- Landscaping Service
- Bulk Drawing Conversion

5. Verticals We Serve

Pinnacle's BIM services bring certainty to every stage of construction for stakeholders across the global AEC industry. We work with:

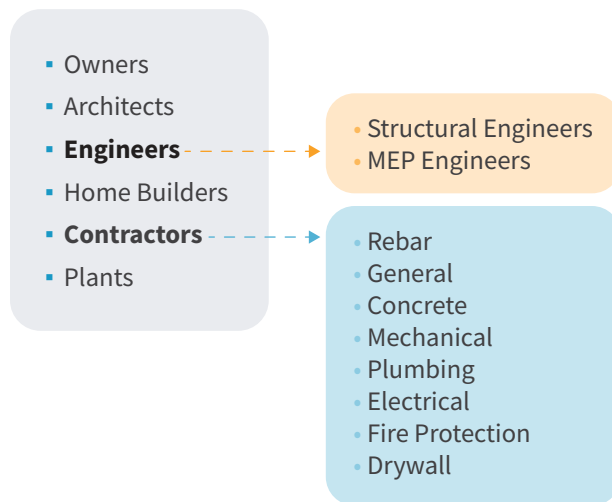

6. Our Work Processes

We strongly emphasize the significance of efficient work process management and consistent communication in the context of outsourcing services. Our process orientation and quality control are per ISO standards – 9001:2015, 27001:2022, 19650-2, 19650-3, and 19650-5. As holders of **ISO 19650-5**, the esteemed international certification for BIM services, we ensure adept data management and transparent collaboration. On orders, we assign a dedicated Relationship Manager, a competent Project Delivery Head, and Project Managers for focused execution.

Relationship Management

Our relationship managers are co-located with customers, ensuring clear communication, managing timelines, and handling deliveries promptly to surpass customer expectations. They advise customers on the services Pinnacle provides and build long-term business relationships.

Production Process

Project teams report to Project Delivery Head (PDH). The PDH provides technical leadership to the team and ensures standard work processes (as per ISO norms) are followed. They oversee project delivery. Project Delivery Heads periodically communicate with the client to get regular feedback and ensure the successful completion of the project.

Project Managers handle small teams for a customer and are responsible for understanding project requirements, project standards, invoicing processes, and communication protocols. They prepare project templates per project specifications, plan resources and align project delivery schedules.

Auditing Process

The COE team is an independent body in the company for Process and quality management and monitors the process and quality through various audit parameters, sets up feedback management processes, carries out investigations in case of any complaints/concerns, and provides action items. This way, Pinnacle ensures consistency in the final deliverables throughout the company.

Quality Control Process

Pinnacle's efficient processes and stringent quality control mechanisms have added certainty to 15000+ projects worldwide. Our process orientation and quality control are per ISO 9001:2015, ISO/IEC 27001:2022, ISO 19650-2, ISO 19650-3, and **ISO 19650-5** standards and are managed by an independent QC team.

7. Awards & Recognition

Pinnacle has won accolades in the form of numerous awards and recognition from the Government, Industry, and prestigious national and international associations.



8. Our Specialized Solutions

Beyond our core services, we also offer enhanced solutions for empowering your business. These solutions include:

PiVDC

Homegrown plugins for Revit and Navisworks to automate repetitive tasks, boosting productivity.

Client Desk

Our 'Glass Kitchen' for your projects that enables real-time progress tracking.

Autodesk Reseller

Personalized support and expertise on Autodesk products.

Autodesk Training Center

Autodesk-certified courses to help your organization or academic institute tap into the next level of Autodesk learning.

Autodesk Academic Partner

Brilliant training facility, friendly processes for professionals and students, powered by top instructors delivering Autodesk excellence!



Authorised Training Centre
Authorised Academic Partner

8. Our Projects

We have successfully executed 15000+ BIM projects for our clients in 43 countries across the world. Our portfolio of projects for our 2000+ customers includes Airports, Manufacturing Units, Data Centres, Hospitals, Stadiums, High-Rise Towers, and more.

Project Statistics - Industry Sectors

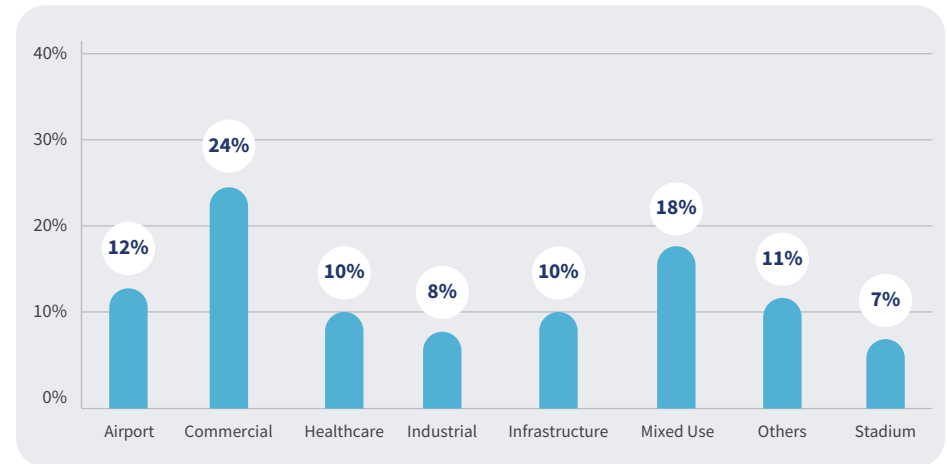

Project Statistics - Segment Wise

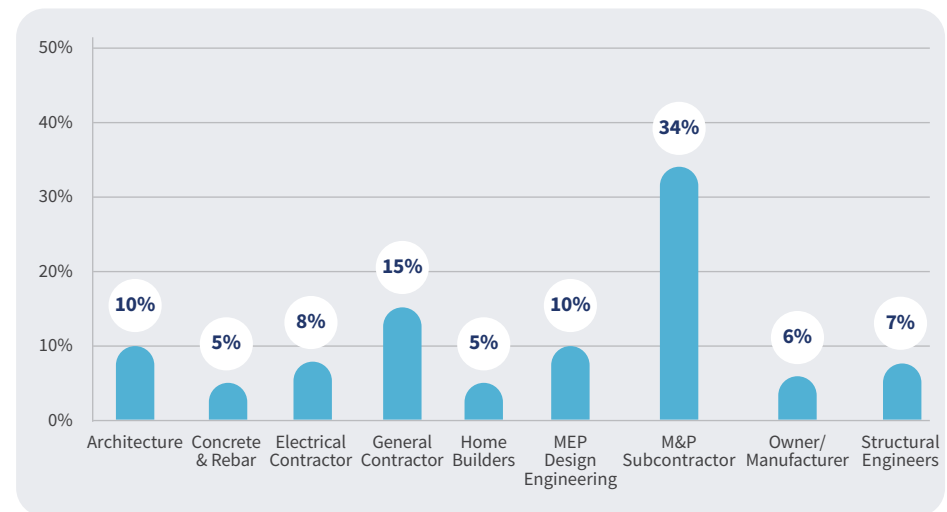

Project Portfolio

Dubai International Airport

Dubai, UAE



ASHRAE Global HQ

Atlanta, USA



St. Mary Magdalene C of E School

Northampton, UK



JW Marriot

Nashville, USA



New Children's Hospital

Dublin, Ireland



Cincinnati Union Terminal

Cincinnati, USA



Project Portfolio

Pulau Tekong

Tekong Island, Singapore



Battersea Power Station

London, England



White Castle Building

Columbus, USA



Lusail Stadium

Lusail, Qatar

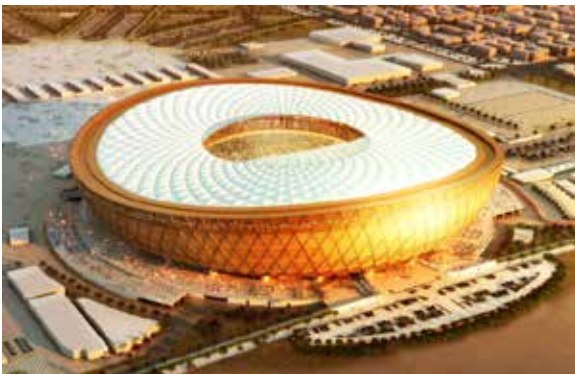

Lord's Cricket Ground

London, England



Berlin Data Center

Berlin, Germany



9. Clients Speak

“It has been very good to work with the Pinnacle team. The team we work with works very hard & always gives 100%.”

Black & McDonald, Canada

Tony Marchione

“Pinnacle Infotech is a valuable business partner in delivering an iconic world-class Project. The most important aspect of having Pinnacle on board is the instrumental role in overcoming challenges by providing satisfying solutions.”

HBK Contracting Company, Qatar

Leonidas Tzevelekas

“The Pinnacle team assigned to my company knows exactly what we expect on each project, and they always deliver. They are quite capable of designing projects on their own with minimal assistance/input from my company.”

Thompson Engineering, USA

Dustin Linquist

“Our Pinnacle team has been very helpful and very dedicated to our projects. The team is very good about asking questions and learning the process while meeting deadlines.”

Commonwealth Electric Company, UK

Stewart Bohrer

“The Pinnacle team has undertaken this project with great care and efficiency, producing a well-coordinated design and providing a well-delivered project for us.”

EMEC Consultancy, UK

J. Dray

“This was a very large project with 5 jobs at the same time. The schedule was aggressive, with lots of DRBs and RFIs to incorporate. Pinnacle did a great job being organized and hit our deadlines almost 100% of the time.”

Hoffman Structures, USA

Garnette Rouse

“Nearly 15% of project costs were reduced as Pinnacle had validated the layout with the shortest path according to the MEP service reduction based on international codes. Pinnacle did an excellent job of deputing a large experienced team of BIM Engineering professionals.”

Jeddah Tower, KSA

Ziad Aboul Hosn

“Working with Pinnacle for detailing services has been very rewarding for our fabrication department. Their commitment to our company is unmatched compared to their competitors', and having a dedicated team for all of our projects makes it a virtually seamless process and gives our fabricators quality drawings every time.”

Winger Contracting Company, USA

Matt Thompson

“Communication between the implementation team was top-notch. I was given updates on a weekly basis and design changes were acted on immediately.”

Thieneman Construction, USA

Matt Elfreich

“I am very pleased with the level of service and, more importantly, the results generated from your services. Thank you for all your services to date, and I look forward to continued success working with your organization in the future.”

BK Gulf, UAE

Costas

“Pinnacle Team was incredible. There were some challenges on our job, and Pinnacle made our lives easier by working alongside our site team seamlessly.”

Modern Niagara, Canada

Chris Gour

“As usual, Pinnacle continues to provide amazing service and outstanding flexibility. The team did an excellent job on this project and finding and solving issues ahead of time.”

Miller Mechanical C & E, USA

Eric Diamond

“Tasked with complicated parameters, the team has performed admirably. There have been multiple occasions where the ability to provide results has been restricted or denied altogether; when those situations have occurred, the Team has been patient and professional while the external obstacles are resolved. Further, the Team has become intimately aware of the process and has been proactive in identifying potential issues and sharing them in a timely fashion - a most helpful and appreciated effort.”

ENGworks Global, USA

Eric Swanson

“This process went very well. Not only did the team deliver what we required, but Pinnacle also advised on better project completion methods.”

William Farrell Limited, Ireland

Owen McSweeney

“Working with the Pinnacle team is a pleasure. All required schedules are met, and their attention to detail is always reflected in the work provided. They are humble, respectful, and always willing to learn new things from a contractor's perspective.”

HPS Mechanical, USA

Scott Fox

India Office Locations

Durgapur - HQ

Pinnacle Infotech Solutions
Bidhannagar, Durgapur, WB 713212
Phone: +91 343 6602222
Fax: +91 343 6602230
Email: info@pinnacleinfotech.com

Madurai

Pinnacle Infotech Solutions
Elcot IT Park, Plot No - 5,6,7, & 8, Vadapalanji,
Madurai, Tamil Nadu, India - 625021
Phone: +91 70100 97363

Jaipur

Pinnacle Infotech Solutions
Mahindra Sez, Jaipur, RJ 302037
Phone: +91 141 722444

Kolkata

Pinnacle Infotech Solutions
Ecospace Business Park, Kolkata 700156
Phone: +91 33 2324 5900

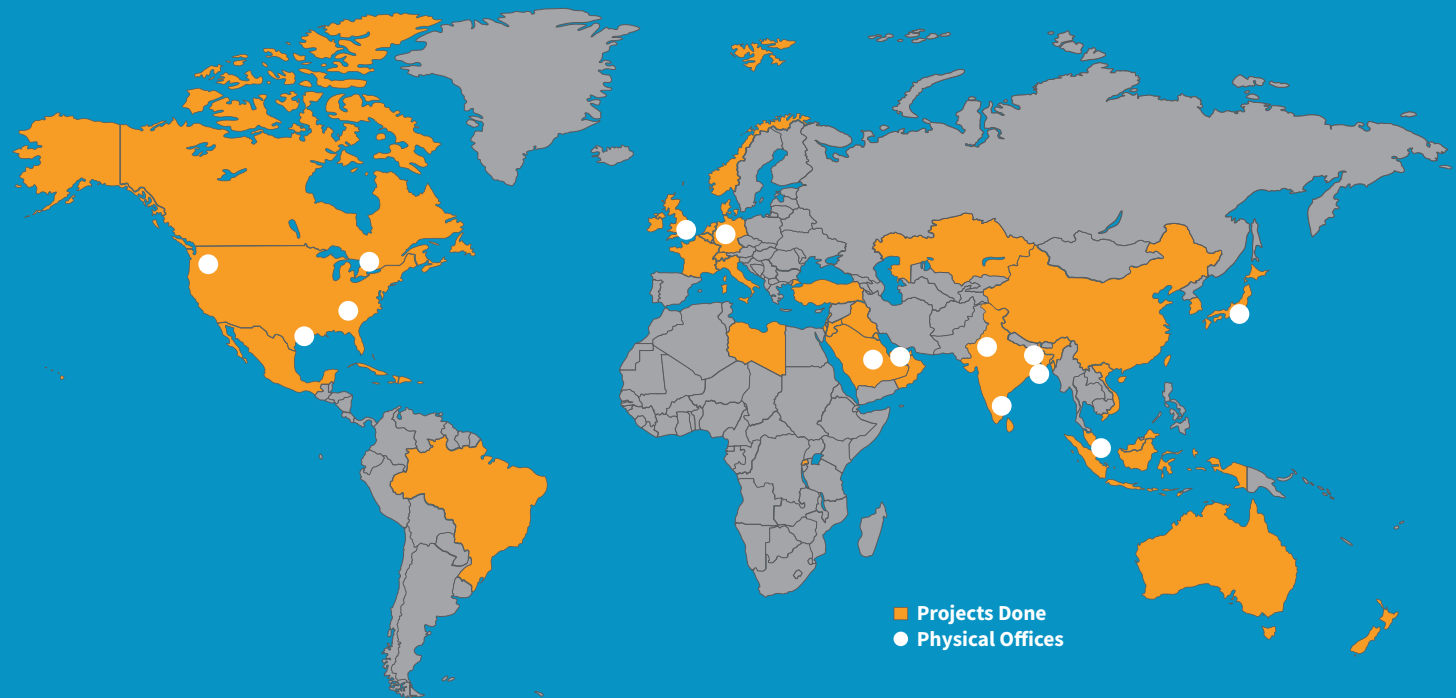

International Office Locations

USA - Houston

Pinnacle Infotech Inc.
50 Sugar Creek Center Blvd,
Sugar Land, TX 77478
Mr. Biswanath Todi
Phone: +1 713 780 2135
Email: btodi@pinnacleinfotech.com

USA - Atlanta

Pinnacle Infotech Inc.
6065 Roswell Rd NE #625,
Atlanta, GA 30328
Mr. Mickey Cantrell
Phone: +1 270 223 6319
Email: mcantrell@pinnacleinfotech.com

USA - San Jose

Pinnacle Infotech Inc.
25, N 14th Street, Suite #670
San Jose, CA 95112
Mr. Nikhil Varandani
Phone: +1 832 863 1870
Email: nvarandani@pinnacleinfotech.com

Canada

Pinnacle VDC Inc.
3250 Bloor Street West, East Tower,
Suite 600, Toronto, ON M8X2X9, Canada
Mr. Cory Houle
Phone: +1 613 290 7477
Email: choule@pinnacleinfotech.com

UK

Pinnacle Infotech Limited
The Barley Mow Centre,
London, W4 4PH
Mr. Pat Saha
Phone: +44 79600 26070
Email: psaha@pinnacleinfotech.com

Germany

Pinnacle BIM Technology GmbH
Brückenstraße 2 / Ludwigstraße 2-6
Köln 50667, Germany
Mr. Arijit Sen
Phone: +49 162 5111 463
Email: arijits@pinnacleinfotech.com

KSA

Pinnacle AEC Solutions
Al Munsiyah, Riyadh 13255
Mr. Majed Alotaibi
Phone: +966 504812625
Email: malotaibi@pinnacleinfotech.com

UAE

Pinnacle Infotech Technologies FZ-LLC
Office No - 307, 3rd Floor, Building No. 7
Dubai Outsourcing Zone, Dubai, UAE
Mr. Yash Goyal
Phone: +971 52 769 7465
Email: dubai@pinnacleinfotech.com

Singapore

Pinnacle BIM Technology PTE. LTD.
BCA Braddell Campus, 200 Braddell Road,
#13-63, Singapore 579700
Mr. Kuntal Chakraborty
Phone: +65 69508205
Email: kchakraborty@pinnacleinfotech.com

Japan

Pinnacle BIM Technology K.K.
#407 7-21-24 Roppongi, Minato-ku,
Tokyo 106-0032, Japan
Mr. So Adachi
Phone: +81 80 3008 9453
Email: sadachi@pinnacleinfotech.com

